

681838

Items		Normal	Remark
Capacity	Typ.	420mAh	0.2CmA(80mA) discharge
	Min.	400mAh	
Voltage		3.7V	0.2CmA(80mA) average voltage
Internal Resistance		≤60mΩ	
Power Off Voltage		2.75V	
Charging Current		400mA	Standard charging
Maximum Charging Voltage		4.25V	
Charging Time		Approx 2.5h	400mA charging
Maximum Charging Current		600mA	1.5CmA
Maximum Discharge Current		800mA	2.0CmA
Approximate Weight		about8g	
Operating Temperature and Humidity	Charging	0~+45°C	
	Discharge	-20~+60°C	
Storage Temperature	<1 month	-20~+45°C	Recommended storage temperature during transportation is at 23 °C
	>6 months	-20~+35°C	

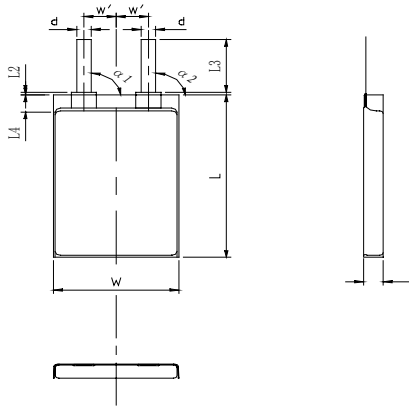

Items	Dimension
T (Max.)	6.8mm
W (Max.)	18.5mm
L (Max.)	38.5mm
L2	1.25±0.75mm
L3	9±1mm
L4	3~4mm
W'	6±1mm
d	5mm
a1	90±5°
a2	90±5°

T: Thickness W': Center Length
W: Width d: Tab Width
L: Length a1: Tab Angle
L2: Tape Height a2: Tab Angle
L3: Tab Height L4: Tab Edge Width

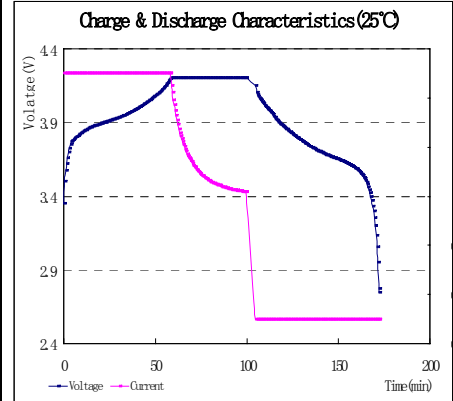

Figure 1 Charge & Discharge Characteristic

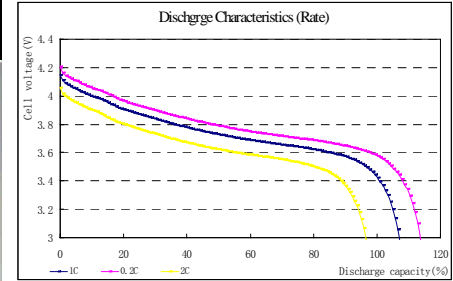

Figure 2 Discharge Characteristic

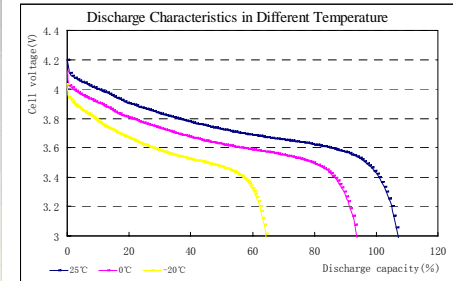

Figure 3 Discharge Characteristic in Different T

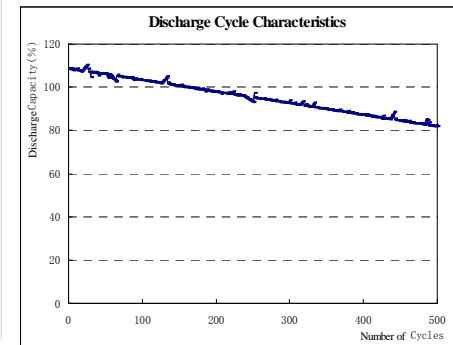

Figure 4 Discharge Cycle Characteristic