

LITHIUM BATTERIES



CR 17250 3.0V 800mAh

lithium-manganese dioxide batteries

Electrical characteristics

(Stored for one year or less)

◉ Nominal Capacity (1mA to 2.0V, at 25°C)	800mAh
◉ Nominal voltage	3.0V
◉ Max continuous discharge current	1000mA
◉ Max. Pulse current Current value is obtaining 2.0V cell voltage when pulse is applied for 15 seconds at 50% discharge depth at 25°C	2000mA
◉ Storage temperature	20°C ~ 30°C
◉ Operating temperature	-40°C ~ 60°C
◉ Weight(approx)	12g

WARNING:

Fire, explosion and severe burn hazard. Do not recharge, crush, disassemble, heat above 100°C, incinerate or expose contents to water.

Key features

- High and stable operating voltage
- Low self-discharge rate
Less than 1% after 1 year of storage at 20°C
- Stainless steel container
- Hermetic glass-to-metal sealing
- Non-flammable electrolyte
- Compliant with IEC 86-4 safety standard
- Non-restricted for transport

UL Component Recognition
File Number MH 45782

Main applications

- TPMS
- Alarms and security system
- Memory back-up
- Tracking system
- Automotive electronics
- Professional electronics
- Computer real-time clocks

.....

LITHIUM BATTERIES

CR17250

lithium-manganese dioxide batteries

Dimensions:

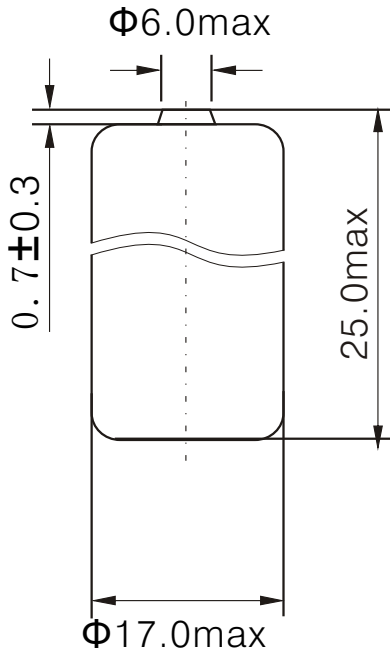

Unit: mm

Available Terminations	
-/P	Axial Pin
-/T /PT2	Radial Pin
-/PT /TP	Polarized Tab

Typical discharge at 25°C

